

FEATURES

- Compact design
- Oversized bearings for long life
- New generation seal system for longer life
- Forged brass manifold with an exclusive lifetime warranty*



SPECIFICATIONS

Pump Model	TC1509S17	TC1511S17	TC1809S17	TC1811S17	TC1507S34	TC1508S34
Maximum Volume	1.75/2.1 GPM	2.1/2.6 GPM	2.5/3.1 GPM	3.25/3.9 GPM	3.0 GPM	3.3 GPM
Maximum Discharge Pressure	2500 PSI	2500 PSI	2200 PSI	2200 PSI	2700 PSI	2500 PSI
Horsepower	3.0/3.6 EBHP	3.6/4.4 EBHP	3.7/4.6 EBHP	4.9/5.8 EBHP	5.5 EBHP	5.65 EBHP
Maximum Pump Speed	1450/1750 RPM				3400 RPM	
Maximum Inlet Pressure	125 PSI					
Minimum Inlet Pressure	3 Ft. Water / 2.6 in. Hg.				Flooded	
Plunger Bore (in / mm)	.591 in / 15 mm		.709 in / 18 mm		.591 in / 15 mm	
Plunger Stroke (in / mm)	.370 in / 9.4 mm	.453 in / 11.5 mm	.370 in / 9.4 mm	.453 in / 11.5 mm	.283 in / 7.2mm	.315 in / 8 mm
Oil Capacity	11.8 oz					
Maximum Fluid Temperature	165°F					
Inlet Port Thread	1/2 - 14 BSP-F					
Discharge Port Thread	3/8 - 19 BSP-F					
Shaft Diameter	.945 in / 24 mm					
Weight	15.2 lbs					
Dimensions	7.6 x 8.0 x 4.9 in					

DIMENSIONAL DRAWING

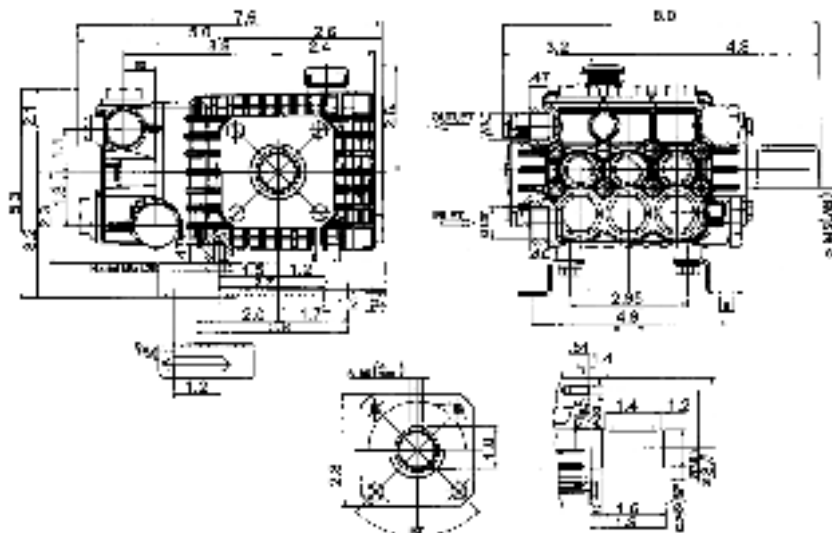

TC Series "60"

GENERAL PUMP *A member of the Interpump Group*

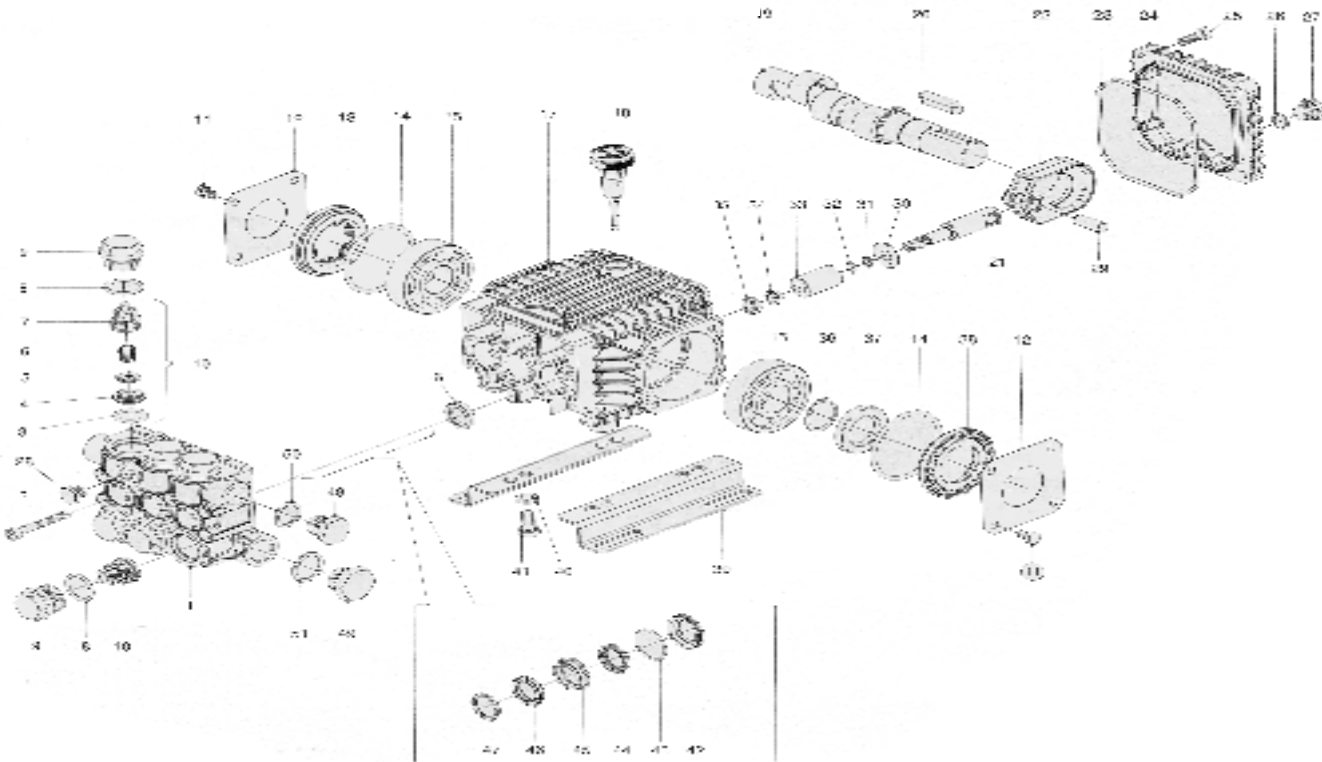

PARTS LIST

ITEM	PART NO.	DESCRIPTION	KIT NO.	QTY.
1.	60120041	Manifold, 15 mm		1
	60120141	Manifold, 18 mm		1
2.	99195000	Screw, M6 x 45		8
3.	90384100	O-ring	123	6
4.	36200366	Valve Seat	123	6
5.	36200176	Valve	123	6
6.	94737600	Spring	123	6
7.	36202551	Valve Cage	123	6
8.	90384700	O-ring		6
9.	98221400	Valve Cap		6
10.	36711501	Valve Assembly	123	6
11.	99180700	Screw, M6 x 10		8
12.	50150074	Bearing Cover		2
13.	44211801	Oil Level Indicator		1
14.	90409700	O-ring		2
15.	91832800	Ball Bearing		2
16.	90156500	Oil Seal	83	3
17.	60010022	Crankcase		1
18.	98210300	Oil Dip Stick		1
19.	60020765	Crankshaft, 7.2 mm Stroke	60020965	1
		Crankshaft, 8.0 mm Stroke		1
19.	60021265	Crankshaft, 9.4 mm Stroke		1
	60021765	Crankshaft, 11.5 mm Stroke		1
20.	91489200	Key		1
21.	60050066	Plunger Guide		3
22.	60030022	Connecting Rod		3
23.	90391800	O-ring, Cover		1
24.	60160022	Rear Crankcase Cover		1
25.	99186700	Screw, M6 x 18		4
26.	90358500	O-ring		1
27.	98204100	Plug, 1/4" G		1
28.	98196600	Plug, 1/8" G		1
29.	97733300	Wrist Pin		3
30.	96707000	Washer		3
31.	90502200	Anti-ext. Ring		3
32.	90357300	O-ring, 5.28x1.78		3
33.	60040009	Ceramic Plunger, 15mm		3
	60040109	Ceramic Plunger, 18mm		3
34.	44211570	Bushing		3
35.	92221600	Nut, M8		3
36.	90063500	Circlip		1
37.	90163400	Oil Seal		1
38.	50211551	Spacer		1
39.	50200074	Pump Foot, 7/8"		2
40.	96701600	Washer		4
41.	99303700	Screw, M8x16		4
42.	60080070	Seal, LP,15mm	200,226	3
	60080170	Seal, LP,18mm	225,227	3
43.	90360400	O-ring, .989x.070	200,225,226,227	3
44.	90260800	Seal, LP, 15 mm	196,226	3
	90265000	Seal, LP, 18mm	197,227	3
45.	60216070	Intermediate Ring, 15	198,226	3
	60216170	Intermediate Ring, 18	199,227	3
46.	90262000	Seal, HP, 15mm	196,226	3
	90268100	Seal, HP, 18mm	197,227	3
47.	51100051	Head Ring, 15mm	196,226	3
	51100151	Head Ring, 18mm	197,227	1
48.	98210000	Plug, 3/8"		1
49.	98217600	Plug, 1/2"		1
50.	96738000	Gasket, Alum., 3/8"		1
51.	96751400	Gasket, Alum., 1/2"		1

REPAIR KITS

KIT NO.	K83	K123	K196 or K197 (15mm) (18mm)	K198 or K199 (15mm) (18mm)	K200 or K225 (15mm) (18mm)	K226 or K227 (15mm) (18mm)
ITEM NO's INCLUDED IN KIT	16	3, 4, 5, 6, 7 (10)	44, 46, 47	45	42, 43	42, 43, 44, 45, 46, 47
NUMBER OF ASSEMBLIES IN KIT	3	6	3	3	3	1
NUMBER OF CYLINDERS KIT WILL SERVICE	3	3	3	3	3	1

TORQUE SPECS*

Pos.	Ft/lb	Nm
2	8.8	12
9	59.0	80
11	7.4	10
25	7.4	10
27	14.7	20
28	9.6	13
35	11.1	15
41	14.7	20
48	29.5	40
49	29.5	40

* Decrease torque by 20% if threads are lubricated

Ref 300538 Rev. B
07-05

GENERAL PUMP 1174 Northland Drive • Mendota Heights, MN 55120
Phone: (651)686-2199 • Fax: (800)535-1745 • e-mail: sales@gpcompanies.com • www.generalpump.com

