

DESCRIPTION

Plunger Pumps are designed for high-pressure industrial washing applications. They are constructed of die-cast bodies and feature a forged brass head with a bayonet style sight glass in the rear and side covers. Internal components include special solid ceramic plungers for long life and durability. Precision cast cooling fins are anodized for maximum heat dissipation. Oversized premium tapered roller bearings and the precision supports assure proper shaft alignment and maximum life. Valve cages of special designed Ultra-Form provide positive seating and extended life. Two-piece connecting rods are a special alloy aluminum-based material oversized for strength and load disbursement. These pumps are designed for gearbox, belt drive, or flex coupled systems, with a 24mm solid crankshaft.



SPECIFICATIONS

MAX GPM	3.96	MAX LMP	15
MAX PSI.....	4350	MAX BAR	300
POWER EBHP	12	BORE DIA. MM.....	20
STROKE MM.....	12.2	WEIGHT LBS.....	34
MAX TEMP	140°	OIL CAPACITY.....	32oz
INLET THREAD	3/4" F	DISCHARGE THREAD	3/8" F

DIMENSIONS

XW-M N version
Solid shaft pump ø 24 mm

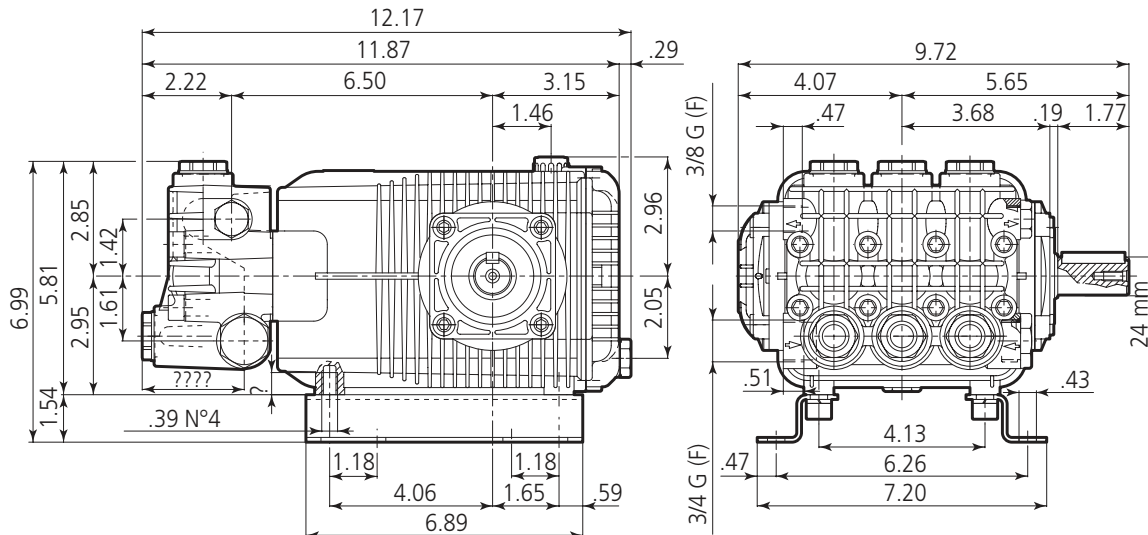

SPECIAL FEATURES

WET END

- **Manifold:**
 - **Forged Brass:** Strength and no porosity – long life. Higher hydrostatic pressures – safety, performance.
 - **Inlet and Discharge Ports:** Heavy bosses for added strength.
 - **Offset Discharge Ports:** High efficiency, smooth flow.
 - **Bolts:** Eight bolts, 10mm, grade 8.8.
- **Valves:**
 - **Ultra Form Cages:** Durable, strength, and long life.
 - **Poppets, Seat and Spring:** 303 and 400 series stainless steel.
 - **Valve Caps:** Forged. *PATENTED VALVE CAP DESIGN*
- **Packing and Plungers:**
 - **High Pressure Packing:** "V" style (D-1) Buna-N (cotton duct weave base) strong and tightens under load.
 - **Low Pressure Seals:** "U" cup double lip Buna-N for a good positive seat.
 - **Support and Guides:** Machined brass, 2-piece construction to assure proper plunger alignment and to maximize packing and seal life.
 - **Plungers:** Are a special aluminum oxide blend, solid ceramic for long life, strong durability and more resilient.

DRIVE END

- **Bearings:** Oversized for maximum life and load disbursement
- **Bearing Support:** Precision die-cast and machined to assure concentricity and alignment.
- **Crankcase:** Precision die-cast, large cross head for strength, large cooling fins and anodized (for maximum heat dissipation).
- **Rear Cover:** Precision die-cast, O-ring sealed and bayonet style sight glass for positive sealing and locking (no threads to loosen).

- **Plunger Rods:** Stainless steel construction for strength (no plating to scrape off), back-up and O-ring plunger sealing system.
- **Rod Pins:** Precision ground and hardened steel, oversized for load disbursement.
- **Connecting Rods:** Heavy 2-piece special alloy aluminum based, oversized for maximum strength, load disbursement, and life. Heavy pin area construction, for added load strength.
- **Crankshaft:** Forged, precision ground and hardened for extremely long life and durability.
- **Oil Seals and O-rings:** All are constructed of Buna-N rubber. The O-rings have stainless steel garter springs to assure constant tension on the sealing surface.
- **Oil Capacity:** 32 oz.

EXTRA FEATURES

- **Dyno Proven:** All pumps are dyno tested to assure the theoretical design meets the actual design.
- **Valve Design:** Each pump series has a valve design that optimizes its highest efficiency.
- **Hot Water:** High temperature kits are available to 180°F. Refer to breakdown.
- **Wet End Repair:** Very simple no special tools required.
- **Design:** Using advanced fluid handling design programs. Overall pump efficiency is increased.

M SERIES PUMPS FEATURES NEW PLUNGER AND PACKING SYSTEMS.