

DESCRIPTION

This AR pump is designed for medium duty loads. It spins at 3400 RPM in a direct drive system coupled with a gasoline engine, the matching flange provides convenient connections to most 3/4" shaft 3.5 – 6.5 HP engines. Optional vertical and horizontal setups. Precision die-cast crankcase with large cooling fins for maximum heat dissipation. Seals and V-Packings designed to continuously lubricate for extended life. Built-in unloader to optimize performance while reducing setup time. Integral trap pressure with fixed or adjustable chemical injector.



SPECIFICATIONS

MAX GPM	2	MAX LMP	7.6
MAX PSI	1450	MAX BAR	100
POWER EBHP	2	BORE DIA. MM	15
STROKE MM	4.8	WEIGHT LBS	11
MAX TEMP	140°	OIL CAPACITY	4.5oz
INLET THREAD	1/2" M	DISCHARGE THREAD	3/8" M

DIMENSIONS

XJV

E version + F8
Hollow shaft pump \varnothing 5/8"

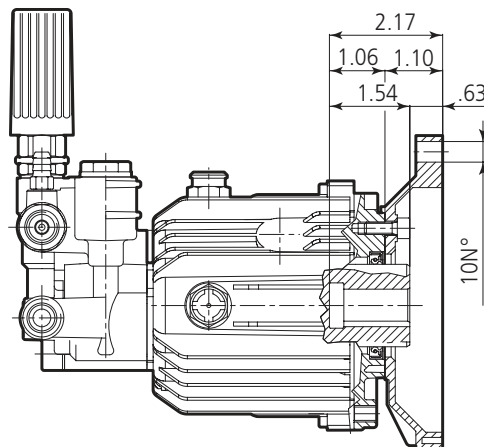
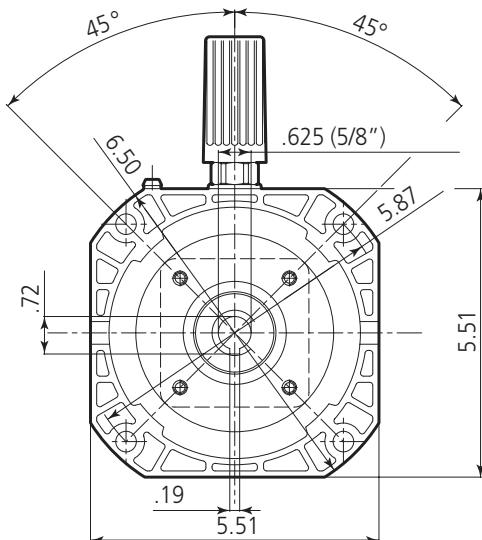

SPECIAL FEATURES

WET END

- **Manifold:**

- **Forged Brass:** Strength and no porosity – long life. Higher hydrostatic pressures – safety.
- **Unloader:** Built in to optimize performance while reducing setup time. Integral trap pressure, fixed or adjustable chemical injector.
- **Bolts:** Three bolts, 10mm, grade 8.8.

- **Valves:**

- **Ultra Form Cages:** Durable, strong, and long life. Unique inlet valve configuration: the valve cage incorporates the high pressure packing head ring.
- **Poppets, Seat and Spring:** 303 and 400 series stainless steel.
- **Valve Caps:** Machined brass for greater strength.

- **Packing and Plungers:**

- **High Pressure Packing:** "V" style (D-1) Buna-N (cotton duct weave base) strong and tightens under load. Continuously lubricating for extended life, self lubricating packing/Plunger guide support ring.
- **Low-Pressure Seals:** "U" cup double lip Buna-N for a good positive seat.
- **Support and Guides:** Machined brass, 1-piece construction to assure proper plunger alignment, maximize packing and seal life.
- **Plungers:** Coated ceramic stainless steel, strong and durable. The pump includes a plunger shoe to distribute the additional plunger load.

DRIVE END

- **Bearings:** Angular contact ball bearing stabilizes the crankshaft and one thrust needle bearing absorbs the plunger load and assures long radial plate life. All of the thrust plates are made of heat treated hardened steel for extended life.

- **Crankcase:** Precision die-cast, large cooling fins and anodized for maximum heat dissipation. Sight glass, fill and drain plugs.

- **Rear Cover:** Precision die-cast, O-ring sealed. The housing retains the crankshaft bearing, oil seal and rear wobble plate bearing support washer.

- **Crankshaft/Wobble Plate:** Precision die-cast to assure proper stroke, duration and alignment.

- **Oil Seals and O-rings:** All are constructed of Buna-N rubber. The oil seals have stainless steel garder springs to assure constant tension on the sealing surface.

- **Oil Capacity:** 4.5 oz.

EXTRA FEATURES

- **Dyno Proven:** All pumps are dyno tested to assure the theoretical design meets the actual design.

- **Valve Design:** Each pump series has a valve design that optimizes its highest efficiency.

- **Wet End Repair:** Very simple no special tools required.

- **Mounting Flanges:** Gasoline SAE J609a flange. Refer to breakdown.

- **Design:** Using advanced fluid handling design programs. Overall pump efficiency is increased.